

CAESAR
GUERINI

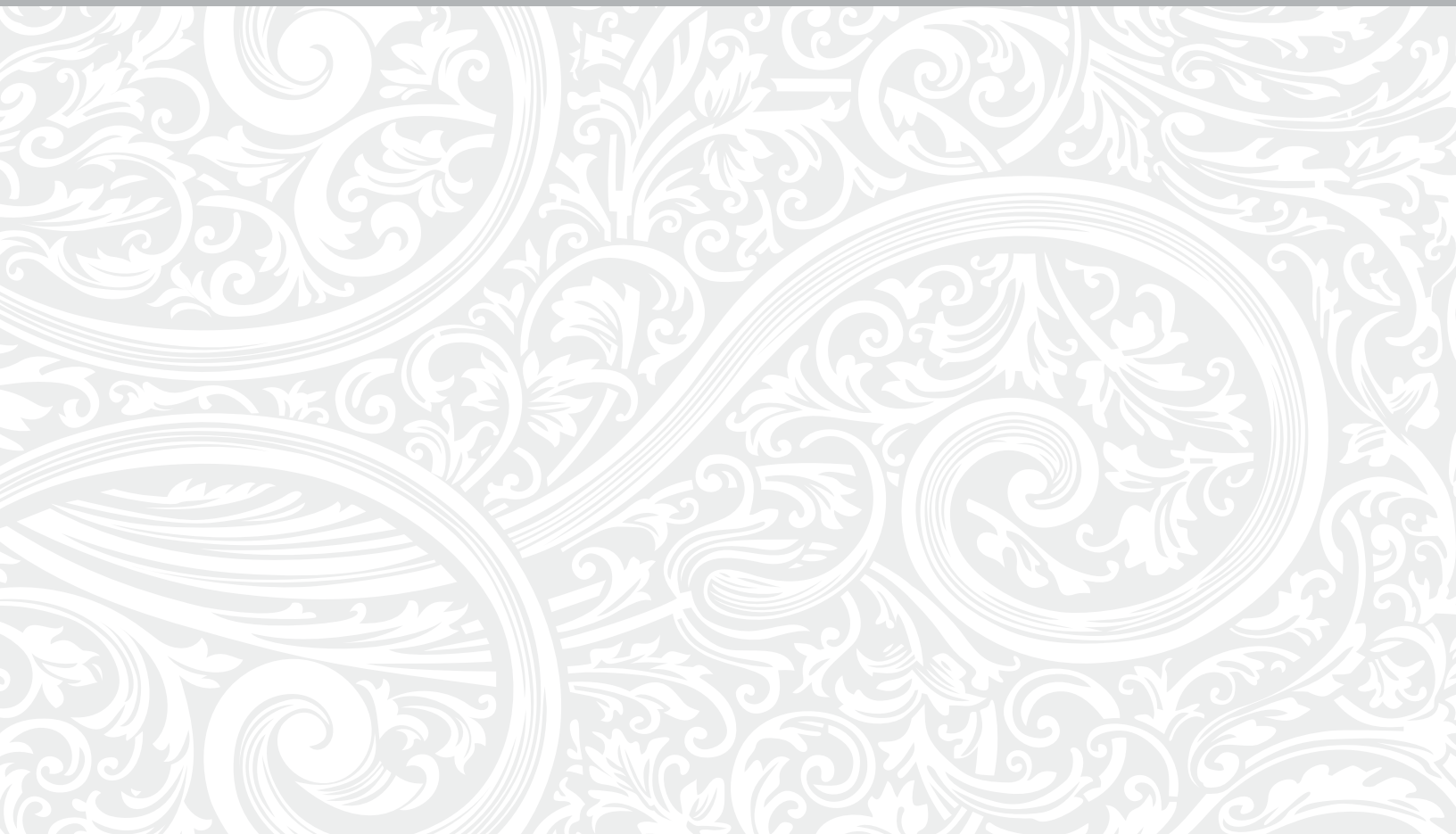

TABLE OF CONTENTS

1	Table of Contents
2	Our Commitment
3-4	Introduction to Field Guns
5-6	Field Gun Features
7-8	Woodlander
9-10	Tempio
11-12	Magnus & Magnus Light
13-14	Maxum
15-16	Ellipse, Ellipse EVO, Ellipse Curve
17-18	Apex
19-20	Forum
21-22	Introduction to Sporting Guns
23-24	Sporting Gun Features
25-28	Sporting Guns
29-30	Ascent Guns
31-32	Introduction to Impact Guns
33-34	Impact Guns
35-36	Introduction to Trap Guns
37-38	Trap Gun Features
39-40	Trap Guns
41-42	Introduction to Invictus Guns
43-44	Invictus Gun Features
45-46	Invictus Guns
47-50	Stock Dimensions
51-52	Custom Shop
53-54	Accessories
55-56	Warranty & Programs
57-58	Caesar Guerini - Brescia, Italy



OUR COMMITMENT

It is our commitment to an unending quest for excellence that makes a Caesar Guerini unique from all other over-and-unders. You can see it in the wood-to-metal fit, the deep lustrous bluing, and the flawless 26 lines per inch checkering. You can feel it in the precision of the internal parts machined from billet steel, as well as the lively balance and handling of our guns. Every Caesar Guerini shotgun goes through no less than 256 quality control checks assuring our product exceeds the demands of our customers.

Our real commitment to our customers is not in simply providing the best product possible. It is also in giving them a level of unprecedented customer service. From our industry leading warranty and ground breaking PitStop program, to our timely service measured in days not months. We strive to leave every customer, a satisfied customer. That is the Caesar Guerini commitment.

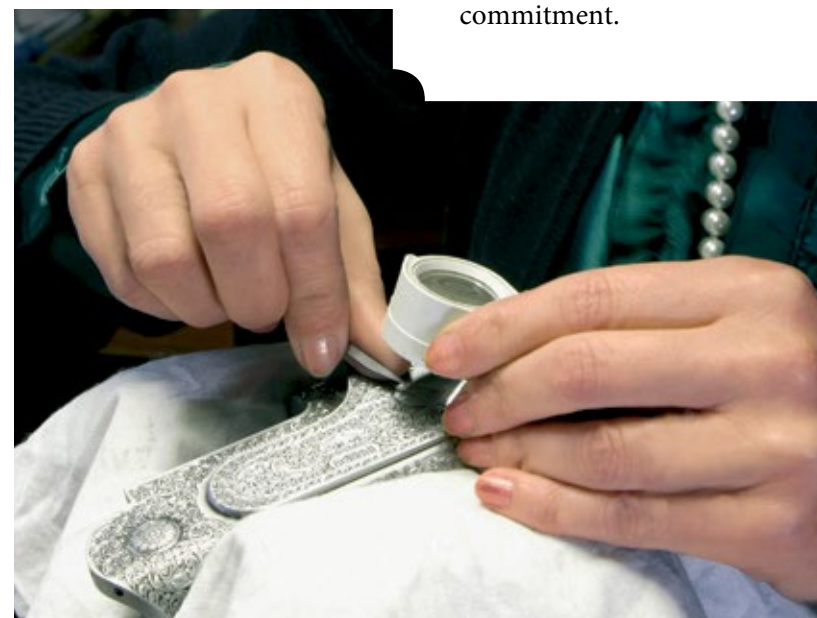



CAESAR
GUERINI



FIELD GUNS

There are three things you want to take hunting with you; a well-trained dog, a good friend and a great shotgun... we can help you with the shotgun. A great bird gun has to become like an extension of your body. To accomplish this we make shotguns that are light and well balanced. Special care is taken in engineering the barrels to be as light and responsive as possible. On the other end of the shotgun we calibrate the weight of the stock by hollowing out the stock bolt hole, ensuring the gun is perfectly balanced. To further enhance handling we utilize a trim stock design that features swept back open radius pistol grips that enhance the natural pointing characteristics of the shotgun while making the gun comfortable to carry during long days in the field. We take the time to perfectly fit a matching walnut butt plate to make the gun easy to mount without catching on your clothing. These features are focused on making our shotguns as functional as they are beautiful. That is what makes a great shotgun.

FIELD GUN FEATURES

Caesar Guerini shotguns are backed up with a limited **Lifetime Warranty** and the acclaimed **Pit Stop service** program.

Multi gauge combination sets are available.

A special proprietary polishing process results in a deep lustrous blued finish

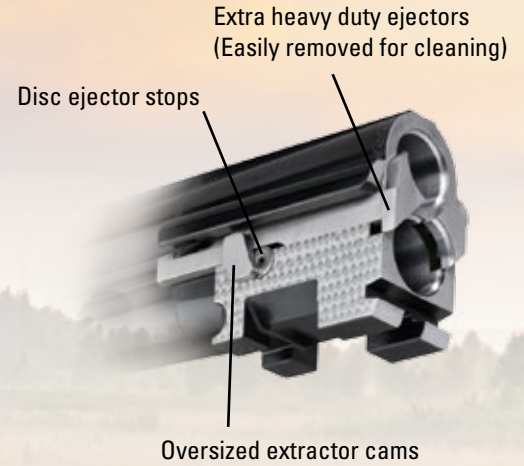

Disc ejector stops

Extra heavy duty ejectors (Easily removed for cleaning)

Oversized extractor cams

Left hand, English straight, and custom stocks are available

Automatic safety (Optional)

Screwless and pinless blind side plates

Light weight models feature forged aluminum frame and fore-end

3" chambers (except 28 gauge)

26 lines-per-inch checkering

Invisalloy clear protective finish.

Replaceable trunnions and locking lug

The trigger incorporates adjustments for take-up and over travel



The fore-end incorporates an interchangeable insert in special hardened steel that makes it easy to tighten the shotgun if it becomes loose through years of very heavy use



Precision fit wood butt plate

Turkish walnut stocks with traditional high luster oil finish, applied by hand

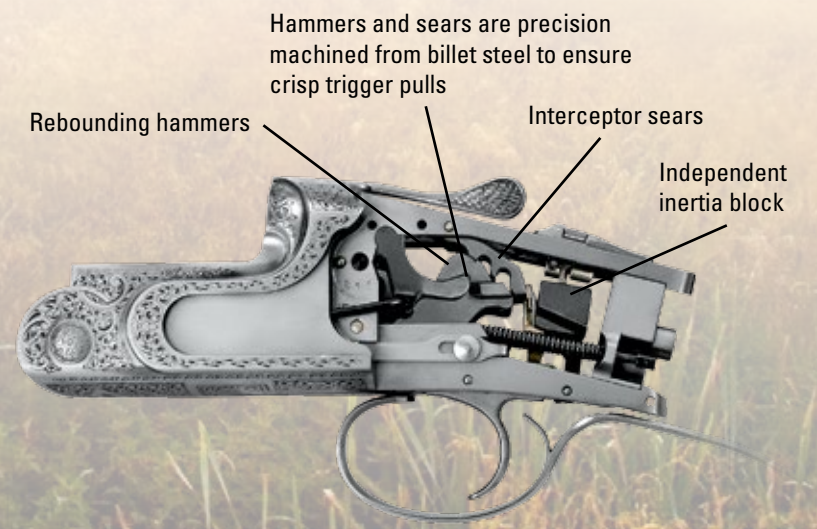

Hammers and sears are precision machined from billet steel to ensure crisp trigger pulls

Rebounding hammers

Interceptor sears

Independent inertia block

Anson push-button fore-end release

Chrome lined chambers and bores

High performance nickel plated choke tubes. (5 included)



All Caesar Guerini shotguns, including the light models, undergo the 1320-bar high-pressure test at the Italian National Proof House.

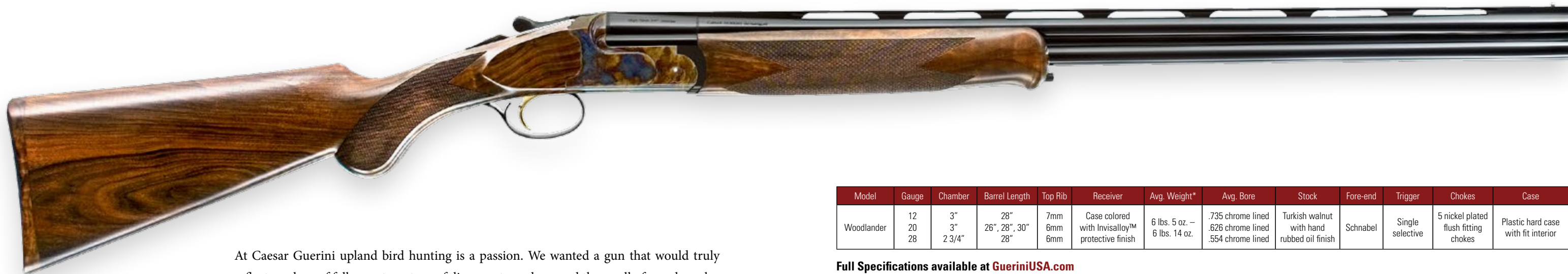

At Caesar Guerini upland bird hunting is a passion. We wanted a gun that would truly reflect our love of fall coverts, autumn foliage, wet gundogs, and the smell of wood smoke. The Woodlander is the shotgun you imagine in such a setting. It was created to be a classic upland game gun for tight cover and fast-flushing birds. The case color hardened action exudes an understated elegance. It is embellished with a single gold ruffed Grouse executed in the Bulino style while nicely figured Turkish walnut featuring a traditional oil finish speaks of quality from a bygone era. The meticulously fitted wood butt plate allows for snag free gun mounts and adds a custom look and feel. The Woodlander is also offered with an optional English straight stock. The lightweight barrels incorporate solid mid ribs to keep out debris, 7mm top rib in 12 gauge and 6mm top rib in sub gauges. If your priorities are traditional good looks and superior handling, then the Woodlander is the gun for you.

Model	Gauge	Chamber	Barrel Length	Top Rib	Receiver	Avg. Weight*	Avg. Bore	Stock	Fore-end	Trigger	Chokes	Case
Woodlander	12 20 28	3" 3" 2 3/4"	28" 26", 28", 30" 28"	7mm 6mm 6mm	Case colored with Invisalloy™ protective finish	6 lbs. 5 oz. – 6 lbs. 14 oz.	.735 chrome lined .626 chrome lined .554 chrome lined	Turkish walnut with hand rubbed oil finish	Schnabel	Single selective	5 nickel plated flush fitting chokes	Plastic hard case with fit interior

Full Specifications available at GueriniUSA.com

Combo sets, additional gauges, and barrel lengths not listed above may be available by special order. See dealer for details.

* Weights may vary based on wood density.





TEMPIO & TEMPIO LIGHT

Model	Gauge	Chamber	Barrel Length	Top Rib	Receiver	Avg. Weight*	Avg. Bore	Stock	Fore-end	Trigger	Chokes	Case
Tempio	12	3"	28"	6mm	Hand polished coin finish with Invisalloy™	6 lbs. 5 oz. – 7 lbs.	.735 chrome lined .626 chrome lined .554 chrome lined	Turkish walnut with hand rubbed oil finish	Schnabel	Single selective	5 nickel plated flush fitting chokes	Plastic hard case with fit interior
	20	3"	28", 30"	7mm								
	28	2 3/4"	28"	6mm								
Tempio Light	12	3"	28"	6mm	Nickel alloy with Invisalloy™ protective finish	5 lbs. 5 oz. – 6 lbs.	.735 chrome lined .626 chrome lined .554 chrome lined	Turkish walnut with hand rubbed oil finish	Schnabel	Single selective	5 nickel plated flush fitting chokes	Plastic hard case with fit interior
	20	3"	28"	7mm								
	28	2 3/4"	28"	6mm								

Full Specifications available at GueriniUSA.com

Combo sets, additional gauges, and barrel lengths not listed above may be available by special order. See dealer for details.

* Weights may vary based on wood density.

Previously chosen by the Editors of Field and Stream Magazine as “Best of the Best” in Shotguns, the Tempio is designed to be a sleek and fast pointing shotgun in the field; the perfect companion for upland game hunters. Its low-profile receiver matched with a trim stock, classic Prince-of-Wales grip and Schnabel fore-end make the gun a perfect match for fast game birds. The Tempio features a contemporary style of “ornato” style scroll with tasteful gold accents. The action is further enhanced by a hand polished coin finish protected by our proprietary Invisalloy™ coating. Each Caesar Guerini game gun is carefully engineered to balance near the hinge point, distributing the weight evenly between the hands, which is the secret to a finely crafted shotgun. The Tempio also features a deluxe grade of Turkish walnut enhanced with a hand rubbed oil finish.





MAGNUS



MAGNUS LIGHT

The Magnus is designed to appeal to the discriminating hunter who appreciates a classic shotgun with timeless qualities. The elegantly sculpted side-plate receiver features upgraded engraving with ornamental scroll and gold game scenes against a richly case colored finish while the Magnus Light features a brilliant nickel finish. The unique side-plates have no pins or screws allowing for a perfectly smooth receiver with uninterrupted engraving. The Magnus series receives a deluxe grade Turkish walnut stock with a traditional hand rubbed oil finish to enhance the highly figured grain. The meticulously fitted wood butt plate allows for snag-free gun mounts and adds a custom look and feel. Best of all, Caesar Guerini is bringing you these significantly enhanced features without enhancing the price.

Model	Gauge	Chamber	Barrel Length	Top Rib	Receiver	Avg. Weight*	Avg. Bore	Stock	Fore-end	Trigger	Chokes	Case
Magnus	12	3"	28", 30"	7mm	Case colored with Invisalloy™ protective finish	6 lbs. 5 oz. – 7 lbs.	.735 chrome lined .626 chrome lined .554 chrome lined	Turkish walnut with hand rubbed oil finish	Schnabel	Single selective	5 nickel plated flush fitting chokes	Plastic hard case with fit interior
	20	3"	28", 30"	6mm								
	28	2 3/4"	28"	6mm								
Magnus Light	12	3"	26", 28"	7mm	Nickel alloy with Invisalloy™ protective finish	5 lbs. 5 oz. – 6 lbs.	.735 chrome lined .626 chrome lined .554 chrome lined	Turkish walnut with hand rubbed oil finish	Schnabel	Single selective	5 nickel plated flush fitting chokes	Plastic hard case with fit interior
	20	3"	26", 28"	6mm								
	28	2 3/4"	28"	6mm								

Full Specifications available at GueriniUSA.com

Combo sets, additional gauges, and barrel lengths not listed above may be available by special order. See dealer for details.

* Weights may vary based on wood density.

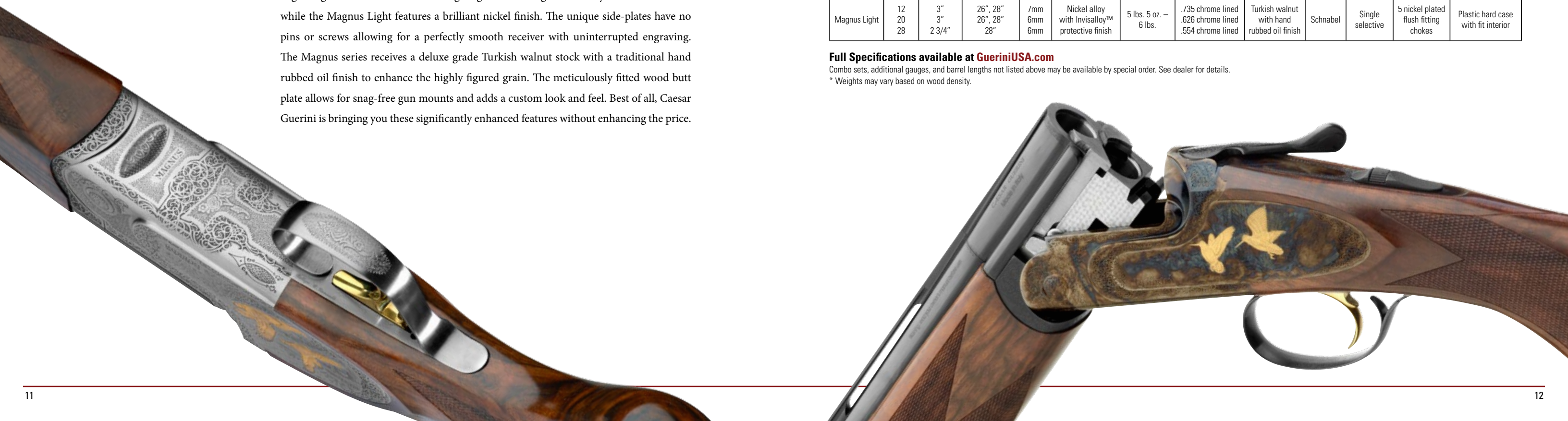

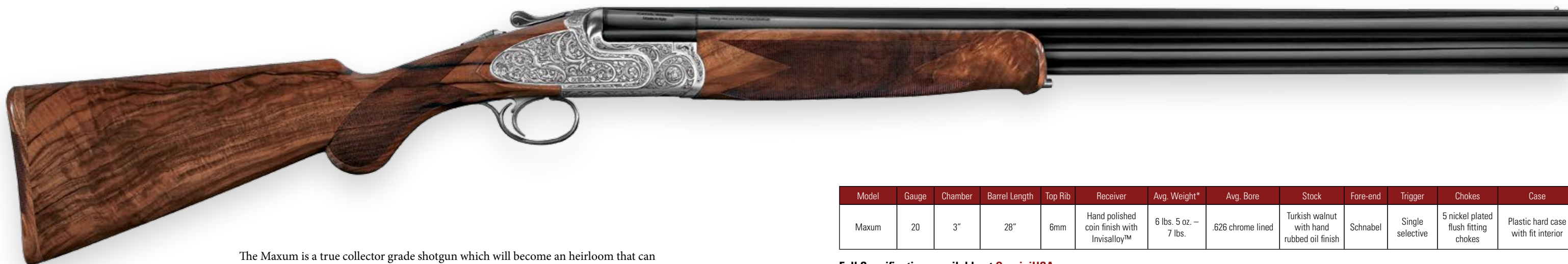

The Maxum is a true collector grade shotgun which will become an heirloom that can be passed down for future generations to enjoy. The action features an elegant coin finish enhanced by deep relief Italian ornato style scrollwork. Hours of hand engraving by the talented craftsmen from the world renowned Italian engraving house, Bottega Incisioni C. Giovanelli, enhance the finest details. Our Invisalloy™ finish is applied to all external surfaces of the action to provide rust resistance and offer ease of care. Balancing the beauty of the deeply sculpted engraving is a deluxe grade of Turkish walnut, featuring the precision cut 26 lines-per-inch checkering and a natural oil finish that is hand rubbed to a stunning sheen. The barrels are highlighted by the upscale feature of a tapered solid top rib. All of these enhancements result in what can only be appreciated as a functional and elegant work of art.

Model	Gauge	Chamber	Barrel Length	Top Rib	Receiver	Avg. Weight*	Avg. Bore	Stock	Fore-end	Trigger	Chokes	Case
Maxum	20	3"	28"	6mm	Hand polished coin finish with Invisalloy™	6 lbs. 5 oz. – 7 lbs.	.626 chrome lined	Turkish walnut with hand rubbed oil finish	Schnabel	Single selective	5 nickel plated flush fitting chokes	Plastic hard case with fit interior

Full Specifications available at GueriniUSA.com

Combo sets, additional gauges, and barrel lengths not listed above may be available by special order. See dealer for details.

* Weights may vary based on wood density.



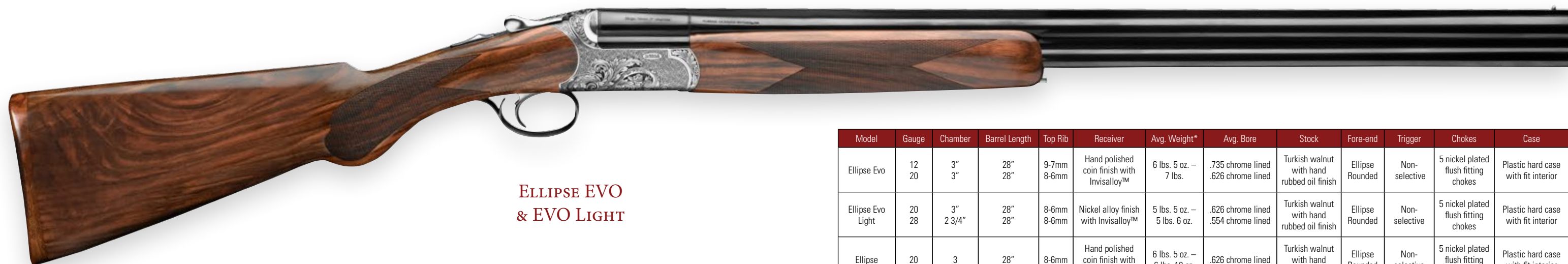

ELLIPSE EVO
& EVO LIGHT



ELLIPSE



ELLIPSE CURVE

Model	Gauge	Chamber	Barrel Length	Top Rib	Receiver	Avg. Weight*	Avg. Bore	Stock	Fore-end	Trigger	Chokes	Case
Ellipse Evo	12 20	3" 3"	28" 28"	9-7mm 8-6mm	Hand polished coin finish with Invisalloy™	6 lbs. 5 oz. – 7 lbs.	.735 chrome lined .626 chrome lined	Turkish walnut with hand rubbed oil finish	Ellipse Rounded	Non-selective	5 nickel plated flush fitting chokes	Plastic hard case with fit interior
Ellipse Evo Light	20 28	3" 2 3/4"	28" 28"	8-6mm 8-6mm	Nickel alloy finish with Invisalloy™	5 lbs. 5 oz. – 5 lbs. 6 oz.	.626 chrome lined .554 chrome lined	Turkish walnut with hand rubbed oil finish	Ellipse Rounded	Non-selective	5 nickel plated flush fitting chokes	Plastic hard case with fit interior
Ellipse	20	3	28"	8-6mm	Hand polished coin finish with Invisalloy™	6 lbs. 5 oz. – 6 lbs. 10 oz.	.626 chrome lined	Turkish walnut with hand rubbed oil finish	Ellipse Rounded	Non-selective	5 nickel plated flush fitting chokes	Plastic hard case with fit interior
Ellipse Curve	20 28	3" 2 3/4"	28" 28"	8-6mm 8-6mm	Hand polished coin finish with Invisalloy™	6 lbs. 5 oz. – 6 lbs. 10 oz.	.626 chrome lined .554 chrome lined	Turkish walnut with hand rubbed oil finish	Ellipse Rounded	Non-selective	5 nickel plated flush fitting chokes	Plastic hard case with fit interior

Full Specifications available at GueriniUSA.com

Combo sets, additional gauges, and barrel lengths not listed above may be available by special order. See dealer for details.

* Weights may vary based on wood density.



ELLIPSE CURVE

Fast as a Grouse's wing tip, sleek as a Pheasant's tail feather - the Caesar Guerini Ellipse series represents the next generation of upland game guns. With graceful rounded actions and streamlined stocks they handle, feel and look like the world's best handmade round body shotguns. We obsessed over every detail from the engraving created to accentuate the curve of the action to something as obscure as the shape of the trigger. This is not a quick makeover of our existing models; the barrels, action and stock are all different. The Ellipse is simply the evolution of the fine Over and Under hunting gun.

With the EVO Light, less is more. Less weight with an alloy action incorporating special stainless steel breech inserts for extended durability. Revolutionary engraving and metal finishing techniques were developed to bring out the depth and contrast in the EVO light engraving. The result is beauty rarely seen in alloy action guns.



ELLIPSE CURVE



ELLIPSE EVO
& EVO LIGHT



Model	Gauge	Chamber	Barrel Length	Top Rib	Receiver	Avg. Weight*	Avg. Bore	Stock	Fore-end	Trigger	Chokes	Case
Apex	20	3"	28"	8-6mm	Hand polished coin finish with Invisalloy™	6 lbs. 5 oz. – 7 lbs.	.626 chrome lined	Turkish walnut with hand rubbed oil finish	Rounded	Single selective	5 nickel plated flush fitting chokes	Plastic hard case with fit interior

Full Specifications available at GueriniUSA.com

Combo sets, additional gauges, and barrel lengths not listed above may be available by special order. See dealer for details.
* Weights may vary based on wood density.

At Caesar Guerini we have a driving passion for innovation and elevating the gunmaker's art, and this commitment to quality has produced the Apex. It has distinctly British lines with a trim pistol grip and our trim rounded fore-end, but what really sets this gun apart is its revolutionary full-length trigger guard. We've eliminated the screws for a clean seamless look, and the end of the guard terminates in a perfectly fitted skeletal grip cap for a touch of elegance. The action is embellished with full-coverage engraving that incorporates no fewer than four different techniques, and the frame's hand-polished coin finish is treated to our Invisalloy™ coating, which makes the metal rust resistant while enhancing the contrast in the engraving. The Apex features a classically British style stock including a rounded fore-end for a sleek but functional profile.



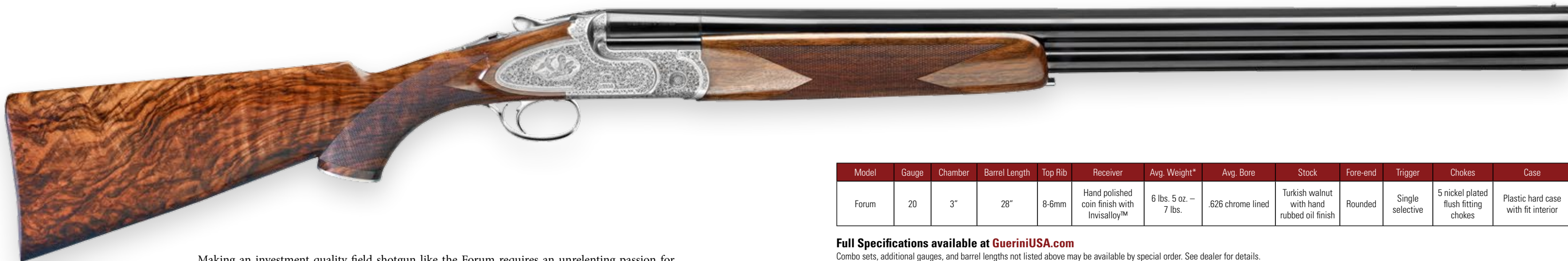

Model	Gauge	Chamber	Barrel Length	Top Rib	Receiver	Avg. Weight*	Avg. Bore	Stock	Fore-end	Trigger	Chokes	Case
Forum	20	3"	28"	8-6mm	Hand polished coin finish with Invisalloy™	6 lbs. 5 oz. – 7 lbs.	.626 chrome lined	Turkish walnut with hand rubbed oil finish	Rounded	Single selective	5 nickel plated flush fitting chokes	Plastic hard case with fit interior

Full Specifications available at GueriniUSA.com

Combo sets, additional gauges, and barrel lengths not listed above may be available by special order. See dealer for details.

* Weights may vary based on wood density.

Making an investment quality field shotgun like the Forum requires an unrelenting passion for precision, premium quality and attention to the smallest details available only from the best of skilled craftsmen and gunsmiths. The results cannot be produced by even the most sophisticated computer controlled machines. Each Forum shotgun we create incorporates numerous hours of skilled hand labor. The engraving on the Forum has been enhanced to include more coverage and detail. The Forum also features our revolutionary full-length trigger guard that is notably missing any retaining screws for a clean seamless look. The end of the trigger guard terminates in a perfectly fitted skeletal grip cap, making for a uniquely elegant appearance. The Forum field stock has a classic Prince-of-Wales style grip which matches perfectly with our trim rounded fore-end giving the gun distinctly British lines. The stock is completed with precisely cut extra fine checkering, checkered butt and a hand rubbed oil finish.





CAESAR
GUERINI



SPORTING GUNS

One of the secrets to being a great shooter is that you can't doubt your equipment. If you are wondering if you have the correct ammo or if your shotgun is not performing properly you will not be concentrating on the most important issue... breaking targets. We design our shotguns to take away any doubt.

Our shotguns are famous for their dependability and while that is critical, it is only a good starting point. Caesar Guerini sporting clays shotguns are carefully engineered to balance and point naturally. We design light responsive barrels that allow each gun to have that magical combination of responsiveness and stability. To make sure the gun points where the shooter is looking, every stock dimension is obsessed over and refined many times by minute increments until we are sure they are optimized. Every part is held to under one thousandths of an inch tolerance and carefully surfaced hardened to provide a clean crisp trigger pull that stays that way as long as you own the shotgun. All of this engineering is just a small part of what goes into every Caesar Guerini shotgun so you can forget about it and focus on your shooting.

SPORTING GUN FEATURES

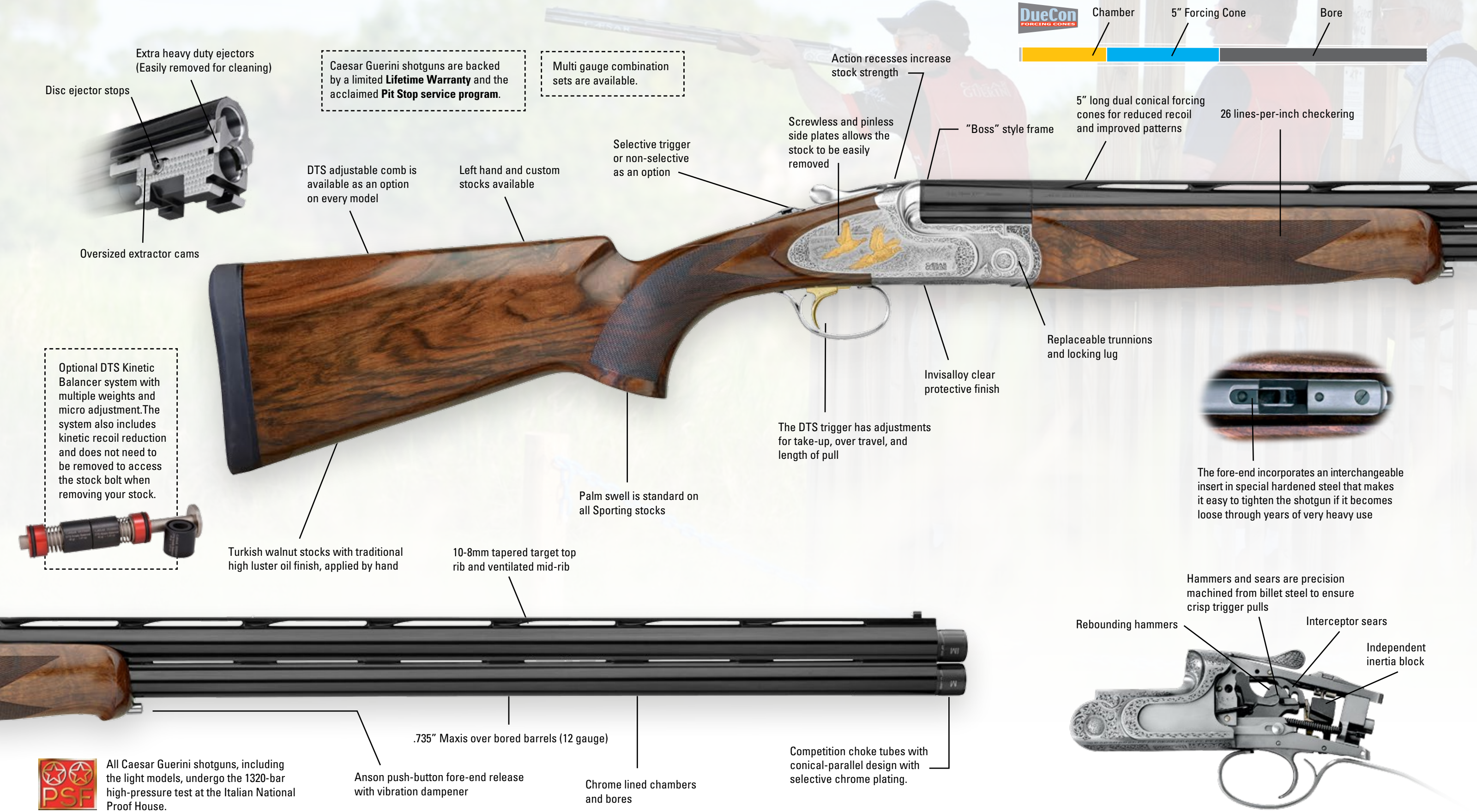

Extra heavy duty ejectors (Easily removed for cleaning)

Disc ejector stops

Oversized extractor cams

Caesar Guerini shotguns are backed by a limited **Lifetime Warranty** and the acclaimed **Pit Stop service program**.

Multi gauge combination sets are available.

DTS adjustable comb is available as an option on every model

Left hand and custom stocks available

Selective trigger or non-selective as an option

Action recesses increase stock strength

Screwless and pinless side plates allows the stock to be easily removed

"Boss" style frame

5" long dual conical forcing cones for reduced recoil and improved patterns

26 lines-per-inch checkering

Replaceable trunnions and locking lug

Invisalloy clear protective finish

The DTS trigger has adjustments for take-up, over travel, and length of pull

Palm swell is standard on all Sporting stocks

The fore-end incorporates an interchangeable insert in special hardened steel that makes it easy to tighten the shotgun if it becomes loose through years of very heavy use

Optional DTS Kinetic Balancer system with multiple weights and micro adjustment. The system also includes kinetic recoil reduction and does not need to be removed to access the stock bolt when removing your stock.

Turkish walnut stocks with traditional high luster oil finish, applied by hand

10-8mm tapered target top rib and ventilated mid-rib

.735" Maxis over bored barrels (12 gauge)

Anson push-button fore-end release with vibration dampener

Chrome lined chambers and bores

Competition choke tubes with conical-parallel design with selective chrome plating.

Hammers and sears are precision machined from billet steel to ensure crisp trigger pulls

Rebounding hammers

Interceptor sears

Independent inertia block



All Caesar Guerini shotguns, including the light models, undergo the 1320-bar high-pressure test at the Italian National Proof House.

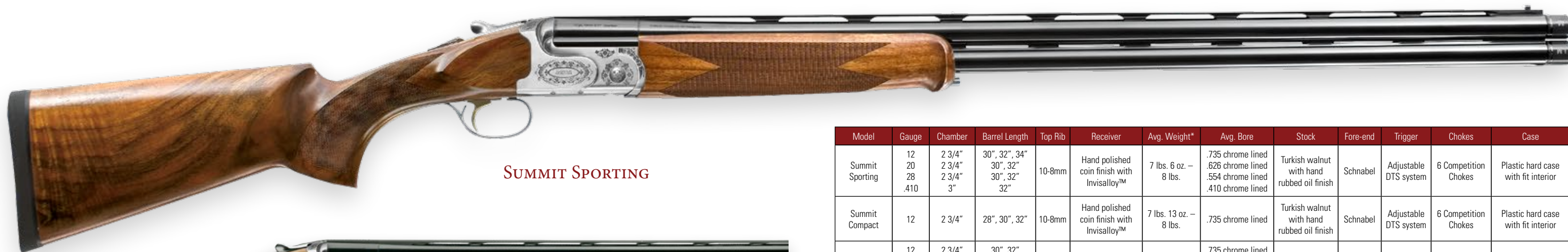

SUMMIT SPORTING



SUMMIT COMPACT

13.75" LENGTH OF PULL



SUMMIT LIMITED

Model shown with Optional DTS stock. Option available for all Sporting models.



CHALLENGER SPORTING



MAGNUS SPORTING



MAXUM SPORTING

Model	Gauge	Chamber	Barrel Length	Top Rib	Receiver	Avg. Weight*	Avg. Bore	Stock	Fore-end	Trigger	Chokes	Case
Summit Sporting	12 20 28 .410	2 3/4" 2 3/4" 2 3/4" 3"	30", 32", 34" 30", 32" 30", 32" 32"	10-8mm	Hand polished coin finish with Invisalloy™	7 lbs. 6 oz. – 8 lbs.	.735 chrome lined .626 chrome lined .554 chrome lined .410 chrome lined	Turkish walnut with hand rubbed oil finish	Schnabel	Adjustable DTS system	6 Competition Chokes	Plastic hard case with fit interior
Summit Compact	12	2 3/4"	28", 30", 32"	10-8mm	Hand polished coin finish with Invisalloy™	7 lbs. 13 oz. – 8 lbs.	.735 chrome lined	Turkish walnut with hand rubbed oil finish	Schnabel	Adjustable DTS system	6 Competition Chokes	Plastic hard case with fit interior
Summit Limited	12 20 28 .410	2 3/4" 2 3/4" 2 3/4" 3"	30", 32" 30", 32" 32" 32"	10-8mm	Case colored with Invisalloy™ protective finish	7 lbs. 6 oz. – 8 lbs.	.735 chrome lined .626 chrome lined .554 chrome lined .410 chrome lined	Turkish walnut with hand rubbed oil finish	Schnabel	Adjustable DTS system	6 Competition Chokes	Plastic hard case with fit interior
Challenger Sporting	12	2 3/4"	30", 32"	10-8mm	Hand polished coin finish with Invisalloy™	7 lbs. 14 oz. – 8 lbs.	.735 chrome lined	Turkish walnut with hand rubbed oil finish	Rounded	Adjustable DTS system	6 Competition Chokes	Plastic hard case with fit interior
Magnus Sporting	12 20 28	2 3/4" 2 3/4" 3"	30", 32" 30", 32" 32"	10-8mm	Hand polished coin finish with Invisalloy™	7 lbs. 6 oz. – 8 lbs.	.735 chrome lined .626 chrome lined .554 chrome lined	Turkish walnut with hand rubbed oil finish	Schnabel	Adjustable DTS system	6 Competition Chokes	Plastic hard case with fit interior
Maxum Sporting	12	2 3/4"	30", 32"	10-8mm	Hand polished coin finish with Invisalloy™	7 lbs. 6 oz. – 8 lbs.	.735 chrome lined	Turkish walnut with hand rubbed oil finish	Schnabel	Adjustable DTS system	6 Competition Chokes	Plastic hard case with fit interior

Full Specifications available at GueriniUSA.com

Combo sets, additional gauges, and barrel lengths not listed above may be available by special order. See dealer for details.

* Weights may vary based on wood density.



DTS ADJUSTABLE COMB



LEFT HANDED STOCK

Optional DTS Adjustable comb and Left handed stocks are available for all sporting models.



MAGNUS
SPORTING

CHALLENGER
SPORTING

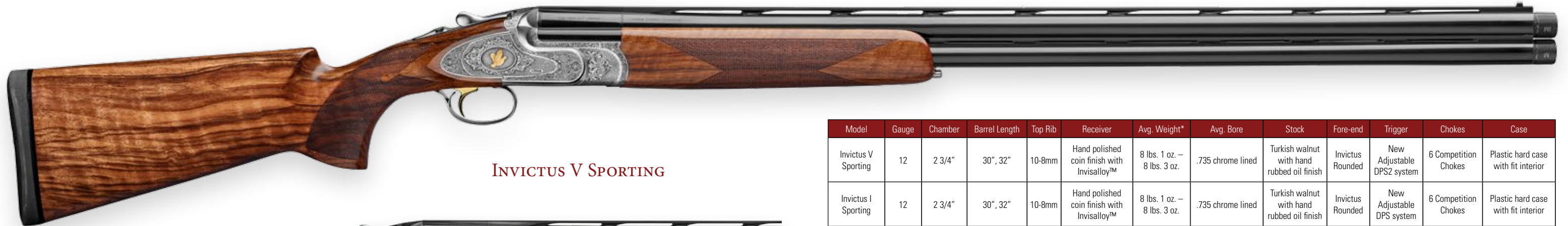

INVICTUS V SPORTING



INVICTUS I SPORTING



ELLIPSE EVO SPORTING



APEX SPORTING



FORUM SPORTING

Model	Gauge	Chamber	Barrel Length	Top Rib	Receiver	Avg. Weight*	Avg. Bore	Stock	Fore-end	Trigger	Chokes	Case
Invictus V Sporting	12	2 3/4"	30", 32"	10-8mm	Hand polished coin finish with Invisalloy™	8 lbs. 1 oz. – 8 lbs. 3 oz.	.735 chrome lined	Turkish walnut with hand rubbed oil finish	Invictus Rounded	New Adjustable DPS2 system	6 Competition Chokes	Plastic hard case with fit interior
Invictus I Sporting	12	2 3/4"	30", 32"	10-8mm	Hand polished coin finish with Invisalloy™	8 lbs. 1 oz. – 8 lbs. 3 oz.	.735 chrome lined	Turkish walnut with hand rubbed oil finish	Invictus Rounded	New Adjustable DPS system	6 Competition Chokes	Plastic hard case with fit interior
Ellipse EVO Sporting	12	2 3/4"	30", 32"	10-8mm	Hand polished coin finish with Invisalloy™	7 lbs. 14 oz. – 8 lbs.	.735 chrome lined	Turkish walnut with hand rubbed oil finish	Ellipse Rounded	Adjustable DTS system	6 Competition Chokes	Plastic hard case with fit interior
Apex Sporting	12	2 3/4"	30", 32"	10-8mm	Hand polished coin finish with Invisalloy™	7 lbs. 14 oz. – 8 lbs.	.735 chrome lined	Turkish walnut with hand rubbed oil finish	Rounded	Adjustable DTS system	6 Competition Chokes	Plastic hard case with fit interior
Forum Sporting	12	2 3/4"	32"	10-8mm	Hand polished coin finish with Invisalloy™	7 lbs. 14 oz. – 8 lbs.	.735 chrome lined	Turkish walnut with hand rubbed oil finish	Rounded	Adjustable DTS system	6 Competition Chokes	Plastic hard case with fit interior

Full Specifications available at GueriniUSA.com

Combo sets, additional gauges, and barrel lengths not listed above may be available by special order. See dealer for details.

*Weights may vary based on wood density.



Optional DTS Kinetic Balancer system with multiple weights and micro adjustment. The system also includes kinetic recoil reduction and does not need to be removed to access the stock bolt when removing your stock.



Barrel Balancer Weights are available for all Caesar Guerini over-and-under target barrels. Weights come as a set and are available in 30 gram, 40 gram, & 50 gram sizes.



ELLIPSE EVO SPORTING

INVICTUS V

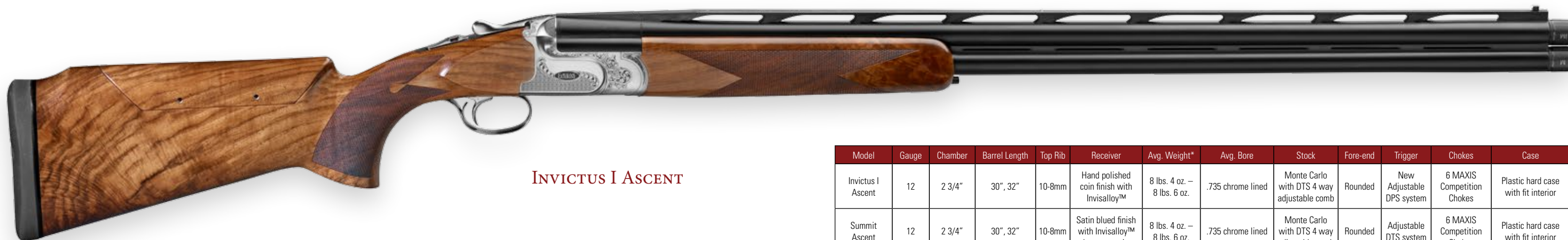

INVICTUS I ASCENT



SUMMIT ASCENT



CHALLENGER ASCENT

Model	Gauge	Chamber	Barrel Length	Top Rib	Receiver	Avg. Weight*	Avg. Bore	Stock	Fore-end	Trigger	Chokes	Case
Invictus I Ascent	12	2 3/4"	30", 32"	10-8mm	Hand polished coin finish with Invisalloy™	8 lbs. 4 oz. – 8 lbs. 6 oz.	.735 chrome lined	Monte Carlo with DTS 4 way adjustable comb	Rounded	New Adjustable DPS system	6 MAXIS Competition Chokes	Plastic hard case with fit interior
Summit Ascent	12	2 3/4"	30", 32"	10-8mm	Satin blued finish with Invisalloy™ clear protection	8 lbs. 4 oz. – 8 lbs. 6 oz.	.735 chrome lined	Monte Carlo with DTS 4 way adjustable comb	Rounded	Adjustable DTS system	6 MAXIS Competition Chokes	Plastic hard case with fit interior
Challenger Ascent	12	2 3/4"	30", 32"	10-8mm	Hand polished coin finish with Invisalloy™	8 lbs. 4 oz. – 8 lbs. 6 oz.	.735 chrome lined	Monte Carlo with DTS 4 way adjustable comb	Rounded	Adjustable DTS system	6 MAXIS Competition Chokes	Plastic hard case with fit interior

Full Specifications available at GueriniUSA.com

Combo sets, additional gauges, and barrel lengths not listed above may be available by special order. See dealer for details.

* Weights may vary based on wood density.

The Ascent is everything you want from a modern sporting clays shotgun without the additional cost of an adjustable point-of-impact rib. The 10mm high tapered top rib is designed to shoot at 50/50% point-of-impact allowing for an upright shooting position and improved target visibility, making it the perfect Sporting Clays gun. The stock incorporates the DTS adjustable comb to make sure a variety of shooters can adjust the gun to fit precisely. The mass in the stock and barrels are engineered so the gun will balance perfectly. With a long list of winning features, the Ascent is taking sporting clays to the next level.

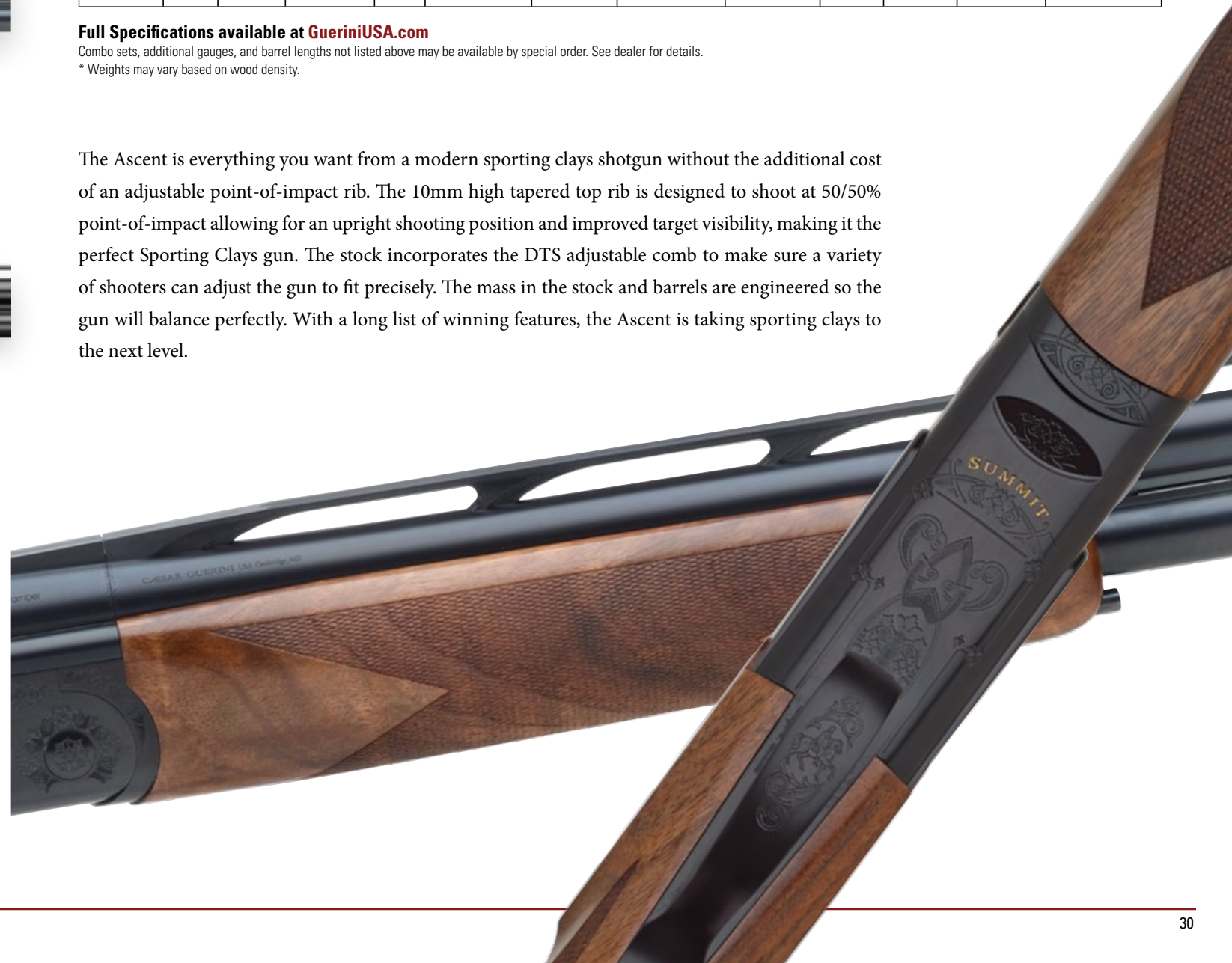



CAESAR
GUERINI



IMPACT GUNS

The objective of the Impact project is to create a shotgun that adapts to you instead of you having to adapt to the gun. Both adjustability and versatility are the hallmarks of the Impact family of guns. In just a few minutes a shooter can customize a long list of features to fit their shooting style and physical dimensions. The 17mm high rib not only allows for a comfortable head-up stance, but is also adjustable for point-of-impact. The trigger can be tuned for over travel, take-up and length-of-pull. A four way adjustable stock comb makes it easy for a shooter to tune the way the gun fits for the perfect sight picture.

We have also engineered a selection of optional accessories that allow the shotgun to be modified for balance, distribution and recoil reduction. The DTS Kinetic Balancer fits in the stock and makes it possible to adjust weight and weight distribution while having the added benefit of being a kinetic recoil reducer. The DTS Barrel Weights are a revolutionary way of dramatically changing the balance and handling characteristics of a shotgun and can be installed onto the barrel and adjusted in seconds without the use of tools. All of these technological advances simply equal a gun that can be tuned to you and your shooting style like no other.



SUMMIT IMPACT



CHALLENGER IMPACT



MAXUM IMPACT



ELLIPSE EVOLUTION



IMPACT SPORTING GUNS

The Impact Sporting features a thin rounded fore-end and light barrels to enhance its natural pointing characteristics. A 20 gauge version is also available with 32" barrels and small gauge tube sets are available for the 12 gauge guns. The 12 gauge version comes in your choice of 30", 32", and 34" barrels.



IMPACT SKEET GUNS

The Impact Skeet is offered with a semi-beavertail fore-end and a selection of 28" or 30" barrels. The trigger is a hybrid design that combines the best attributes of mechanical and inertia trigger designs for reliable functioning with even the lightest loads. A popular option is the full Skeet set that includes Briley Ultra Light skeet tubes and DTS kinetic balancer, DTS barrel weights all in a customized Americase.



IMPACT TRAP GUNS

The Impact Trap offers a mid-height rib alternative to our standard trap model at 17mm high vs. 25mm. Amazingly the Impact has the same range of point-of-impact adjustability as our high rib trap guns due to a new rib mechanism. Additionally, there is an unsingle barrel available in a combo set. The Over and Under comes with 32" barrels and the unsingle is offered in 34".

Model	Gauge	Chamber	Barrel Length	Top Rib	Receiver	Avg. Weight*	Avg. Bore	Stock	Fore-end	Trigger	Chokes	Case
Summit Impact	12 20	2 3/4"	28", 30", 32", 34" 32"	11-9.6mm adjustable POI	Satin blued finish with Invisalloy™ clear protection	7 lbs. 11 oz. – 8 lbs. 12 oz.	.735 chrome lined	Monte Carlo with DTS 4 way adjustable comb	Rounded, or Semi-beavertail with finger grooves	Adjustable DTS system	6 MAXIS Competition Chokes	Plastic hard case with fit interior
Challenger Impact	12	2 3/4"	28", 30", 32", 34"	11-9.6mm adjustable POI	Hand polished coin finish with Invisalloy™	8 lbs. 4 oz. – 8 lbs. 12 oz.	.735 chrome lined	Monte Carlo with DTS 4 way adjustable comb	Rounded, or Semi-beavertail with finger grooves	Adjustable DTS system	6 MAXIS Competition Chokes	Plastic hard case with fit interior
Maxum Impact	12	2 3/4"	30", 32", 34"	11-9.6mm adjustable POI	Hand polished coin finish with Invisalloy™	7 lbs. 11 oz. – 8 lbs. 12 oz.	.735 chrome lined	Monte Carlo with DTS 4 way adjustable comb	Rounded, or Semi-beavertail with finger grooves	Adjustable DTS system	6 MAXIS Competition Chokes	Plastic hard case with fit interior
Ellipse EVolution	12	2 3/4"	32"	10-8mm adjustable POI	Hand polished coin finish with Invisalloy™	8 lbs. 6 oz.	.735 chrome lined	Monte Carlo with DTS 4 way adjustable comb	Ellipse Rounded	Adjustable DTS system	6 MAXIS Competition Chokes	Plastic hard case with fit interior

Full Specifications available at GueriniUSA.com

Combo sets, additional gauges, and barrel lengths not listed above may be available by special order. See dealer for details.

*Weights may vary based on wood density. Impact Sporting models can be up to 9 lbs. 4 oz. with DTS Kinetic Balancer™ and heavy rib torsion rods.

All versions above are available in Summit, Challenger, and Maxum grades*.

*Some versions only available by special order.



CAESAR
GUERINI



TRAP GUNS

At Caesar Guerini we are passionate about trap shooting as a manufacturer and as shooters. We use what we make and make what we want to use. Our line of trap guns incorporates every feature and attribute that makes a great competition gun. Weight, recoil, triggers, adjustability and durability are all scrutinized and refined until the result is a gun that can compete at the highest levels. Once we feel that we have a product that is technically optimized there is only one thing left to do and that is offer options. There are three major barrel configurations, over-and-under, unsingle and top single and they are available in any combination. We even have two rib heights. Stocks are available in right hand, left hand or full custom and of course in many grades of Turkish walnut. You can also choose from a number of engraving grades with everything from minimalistic scroll to full coverage engraving. Caesar Guerini also offers a number of advanced options like the DTS Release Triggers in single or double configuration, DTS Kinetic Balancer providing reduced recoil and DTS Barrel Weights to tune handling dynamics of the shotgun. We made the gun we have always wanted to shoot, now let's go shooting.

TRAP GUN FEATURES

The multi-axis DTS comb allows for the adjustment of: offset, cast, comb height, and comb drop. But adjustability is not helpful unless the system is rugged. The DTS comb hardware is light but extremely simple and strong; designed to stay exactly where you set it.



Over/Under - Optional Barrel
60/40 to 100% high P.O.I.



Unsingle - Optional Barrel
60/40 to 120% high P.O.I.



Top Single - Optional Barrel
60/40 to 100% high P.O.I.

Limited lifetime warranty and free Pit Stop tune-ups.

Selective and non-selective triggers are available.

All barrels and frames are nitro proof tested at 19,140+ p.s.i.

5" long dual conical forcing cone for the perfect balance of velocity and recoil reduction.

Optional DTS Kinetic Balancer system with multiple weights and micro adjustment. The system also includes kinetic recoil reduction and does not need to be removed to access the stock bolt when removing your stock.



Interchangeable trunnions and locking lug.

Interchangeable fore-end inserts allows the action to be tightened.

Optional factory selective release triggers available in single and double release.

DTS trigger system with two trigger pull weight options, take up, over travel, and length of pull adjustments.

Once the proper rib height and angle is obtained you can choose to lock it into place with a locking screw.

The DTS unsingle rib allows the point-of-impact to be adjusted to an industry leading 60/40 to 120% to precisely fit your shooting style. Adjustment is accomplished by simply turning an elevation wheel with positive detents and clear incremental markings.

Hammers and sears are precision machined from billet steel to ensure crisp trigger pulls.

Rebounding hammers

Interceptor sears

Independent inertia block

20mm ventilated recoil pad incorporating soft rubber compound for recoil absorption.

Left hand and custom stock dimensions are available.

Vibration dampening bushings.



All Caesar Guerini shotguns, including the light models, undergo the 1320-bar high-pressure test at the Italian National Proof House.

.735" Maxis oversized bore with chrome lining for optimal ballistic performance.

100 % of our barrels are tested and certified for correct point-of-impact regulation.

Maxis choke system with conical-parallel design and crowned exit radius for maximum pattern performance. A new spanner wrench design with thread cleaner is supplied.



MAXUM TRAP



SUMMIT TRAP



CHALLENGER TRAP



INVICTUS I TRAP



INVICTUS I TRAP RIB

Model	Gauge	Chamber	Barrel Length	Top Rib	Receiver	Avg. Weight*	Avg. Bore	Stock	Fore-end	Trigger	Chokes**	Case
Maxum Trap	12	2 3/4"	32", 34"	12mm adjustable POI	Hand polished coin finish with Invisalloy™	8 lbs. 13 oz. – 9 lbs.	.735 chrome lined	Monte Carlo with DTS 4 way adjustable comb	Semi-beavertail with finger grooves	Adjustable DTS system	3-5 MAXIS Competition Chokes	Plastic hard case with fit interior
Summit Trap	12	2 3/4"	32", 34"	12mm adjustable POI	Hand polished coin finish with Invisalloy™	8 lbs. 13 oz. – 9 lbs.	.735 chrome lined	Monte Carlo with DTS 4 way adjustable comb	Semi-beavertail with finger grooves	Adjustable DTS system	3-5 MAXIS Competition Chokes	Plastic hard case with fit interior
Challenger Trap	12	2 3/4"	32", 34"	12mm adjustable POI	Hand polished coin finish with Invisalloy™	8 lbs. 11 oz. – 9 lbs.	.735 chrome lined	Monte Carlo with DTS 4 way adjustable comb	Semi-beavertail with finger grooves	Adjustable DTS system	3-5 MAXIS Competition Chokes	Plastic hard case with fit interior
Invictus I Trap	12	2 3/4"	32", 34"	12mm adjustable POI	Hand polished coin finish with Invisalloy™	8 lbs. 15 oz. – 9 lbs. 5 oz.	.735 chrome lined	Monte Carlo with DTS 4 way adjustable comb	Invictus Semi-beavertail with finger grooves	New Adjustable DPS system	3-5 MAXIS Competition Chokes	Plastic hard case with fit interior

Full Specifications available at GueriniUSA.com

Combo sets, additional gauges, and barrel lengths not listed above may be available by special order. See dealer for details.

* Weights may vary based on wood density. ** Number of chokes are dependent on Trap model type (Unsingle, Over-and-Under, Top Single).



Barrel Balancer Weights are available for all Caesar Guerini over-and-under target barrels. Weights come as a set and are available in 30 gram, 40 gram, & 50 gram sizes.

Optional DTS Kinetic Balancer system with multiple weights and micro adjustment. The system also includes kinetic recoil reduction and does not need to be removed to access the stock bolt when removing your stock.



Factory release triggers are available for single and double barrels.



SUMMIT TRAP

MAXUM TRAP



CAESAR
GUERINI



INVICTUS: Latin, meaning: unconquerable, undefeated.

A number of years ago we engaged in a study to determine if there was a technical solution for significantly increasing the long term durability of an over-and-under action; more specifically, the problem of an “off face” condition which is created by the barrel and action wearing to the point that there is an unsafe gap between the two. This condition typically spelled the end of a shotgun’s useful wear life. Caesar Guerini’s Invictus action is the first double gun to ever overcome this issue. Due to the modularity of the Invictus system the life span has been increased between 200 and 300% over the typical double gun. We feel this is a quantum leap forward in the evolution of over-and-under shotguns.

EXCLUSIVE INVICTUS FEATURES

THE INVICTUS SYSTEM

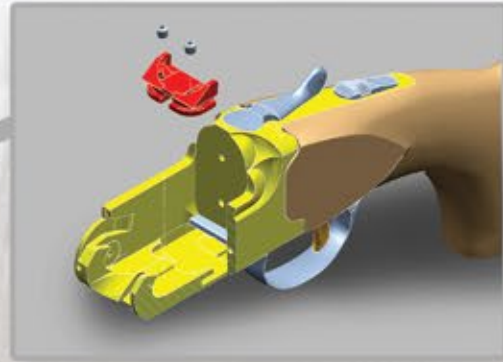

The **Invictus Block** significantly increases the locking surface area between the barrel and the action, dramatically increasing durability. This part is also replaceable multiplying the longevity of the action. The result is a gun that is more durable from the start, but also can be rebuilt in a way no other over-and-under can.

The **wider frame** has larger bearing surfaces between the action and fore-end iron increasing strength while reducing friction.

An **elastomer bushing** has been added to the fore-end assembly to reduce vibration between the pushbutton rod and wood.

The new **DPS (Durability, Precision, Speed)** trigger incorporates redesigned hammers with a different geometry and tighter tolerances. Additionally, the hammers are coated with an industrial chrome that is designed to have a low co-efficient of friction and provide superior lubricity. This makes the trigger durable, precise and consistent.

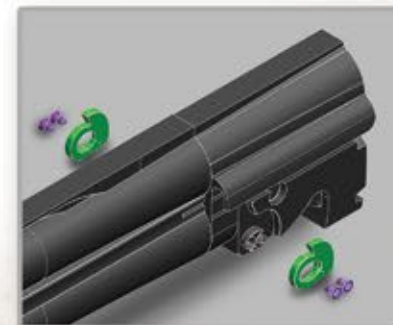

The revolutionary **Invictus Cams** eliminate conventional hinge pins and trunnions. This system makes the Invictus the first double gun that can move the relationship of the barrels to the action. This allows the barrels to be moved rearward to eliminate any potential "off face" condition.

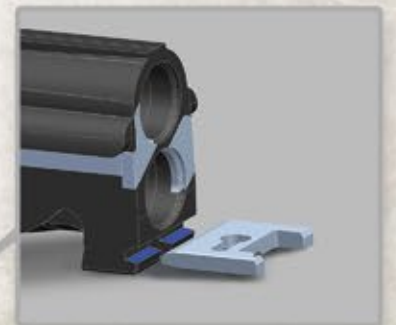

The **contact** between the bolt and monoblock has been enlarged to reduce wear while increasing strength.

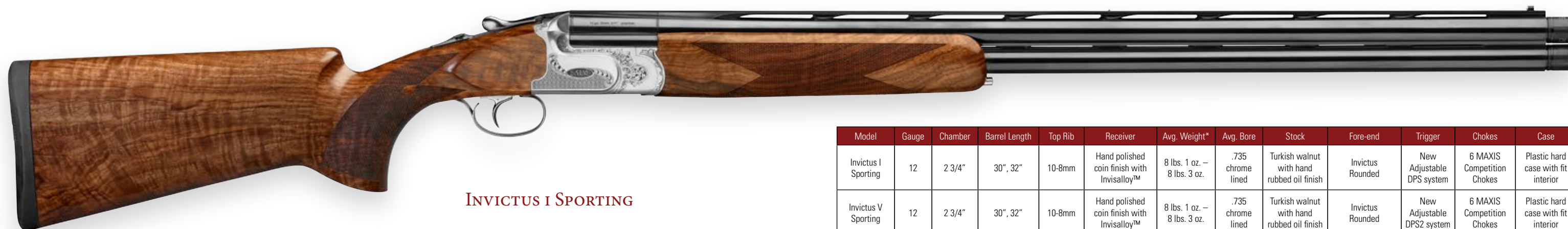

INVICTUS I SPORTING



INVICTUS V SPORTING



INVICTUS I ASCENT



INVICTUS I TRAP - UNSINGLE



INVICTUS I TRAP - OVER/UNDER

Model	Gauge	Chamber	Barrel Length	Top Rib	Receiver	Avg. Weight*	Avg. Bore	Stock	Fore-end	Trigger	Chokes	Case
Invictus I Sporting	12	2 3/4"	30", 32"	10-8mm	Hand polished coin finish with Invisalloy™	8 lbs. 1 oz. – 8 lbs. 3 oz.	.735 chrome lined	Turkish walnut with hand rubbed oil finish	Invictus Rounded	New Adjustable DPS system	6 MAXIS Competition Chokes	Plastic hard case with fit interior
Invictus V Sporting	12	2 3/4"	30", 32"	10-8mm	Hand polished coin finish with Invisalloy™	8 lbs. 1 oz. – 8 lbs. 3 oz.	.735 chrome lined	Turkish walnut with hand rubbed oil finish	Invictus Rounded	New Adjustable DPS2 system	6 MAXIS Competition Chokes	Plastic hard case with fit interior
Invictus I Ascent	12	2 3/4"	30", 32"	10-8mm	Hand polished coin finish with Invisalloy™	8 lbs. 4 oz. – 8 lbs. 6 oz.	.735 chrome lined	Turkish walnut with hand rubbed oil finish	Invictus Rounded	New Adjustable DPS system	6 MAXIS Competition Chokes	Plastic hard case with fit interior
Invictus I Trap	12	2 3/4"	32", 34"	12mm adjustable POI	Hand polished coin finish with Invisalloy™	8 lbs. 15 oz. – 9 lbs. 5 oz.	.735 chrome lined	Monte Carlo with DTS 4 way adjustable comb	Invictus Semi-beavertail with finger grooves	New Adjustable DPS system	3-5 MAXIS Competition Chokes**	Plastic hard case with fit interior

Full Specifications available at GueriniUSA.com

Combo sets, additional gauges, and barrel lengths not listed above may be available by special order. See dealer for details.

* Weights may vary based on wood density. ** Number of chokes are dependent on Trap model type (Unsingle, Over-and-Under, Top Single).

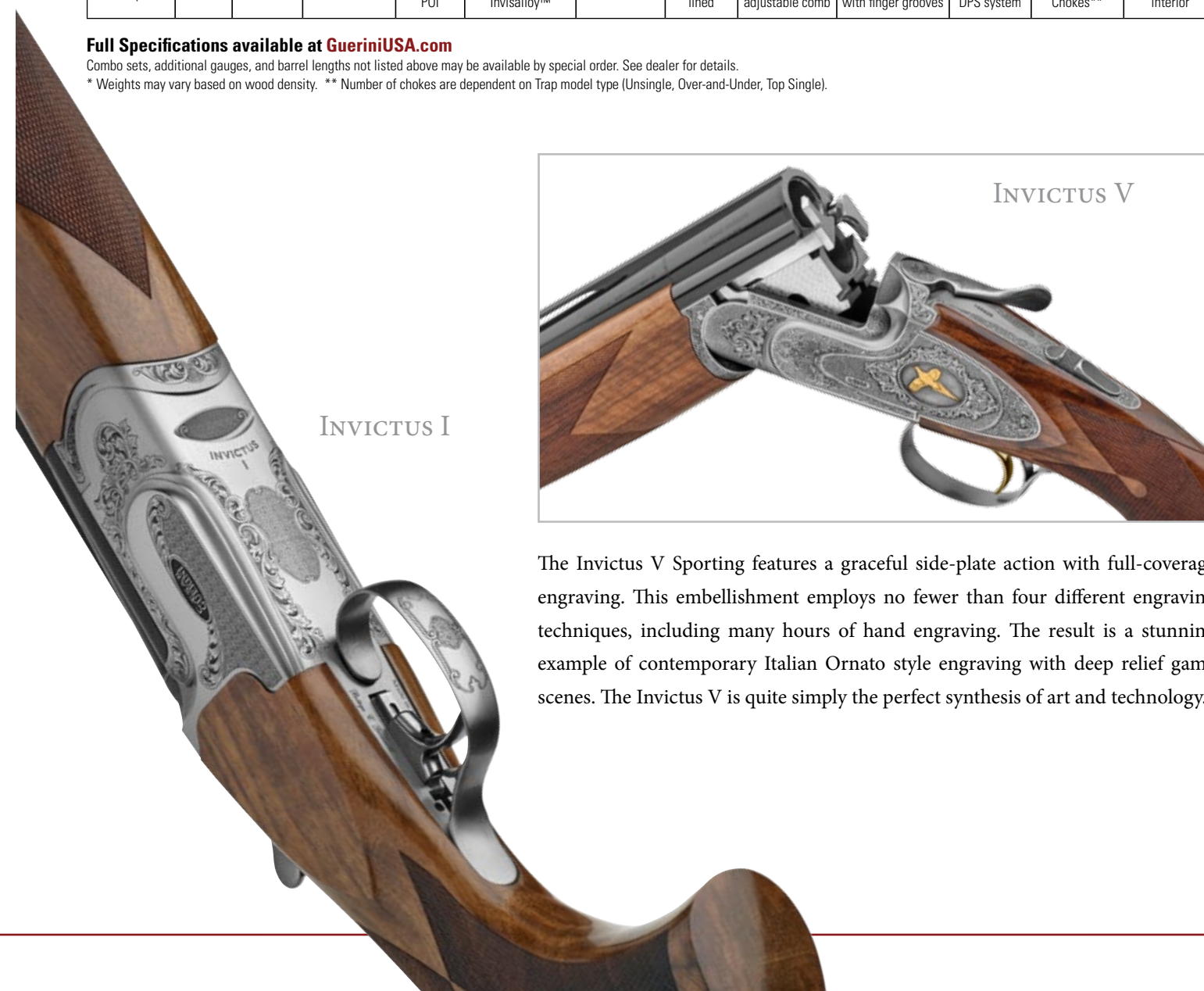

INVICTUS I



INVICTUS V

The Invictus V Sporting features a graceful side-plate action with full-coverage engraving. This embellishment employs no fewer than four different engraving techniques, including many hours of hand engraving. The result is a stunning example of contemporary Italian Ornato style engraving with deep relief game scenes. The Invictus V is quite simply the perfect synthesis of art and technology.

FIELD STOCK



SPORTING CLAYS STOCK



ELLIPSE FIELD STOCK



IMPACT STOCK



ASCENT STOCK



EVOLUTION STOCK

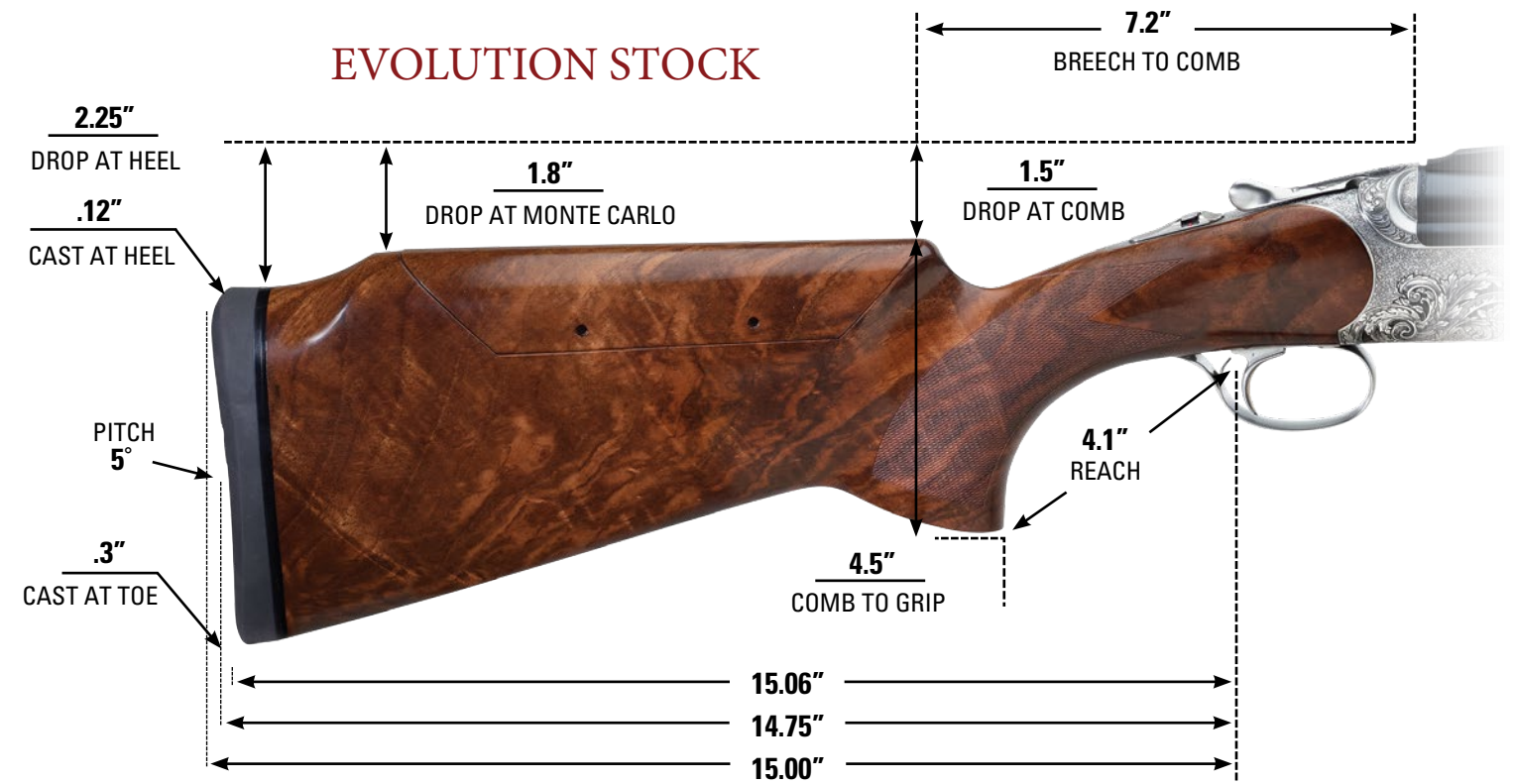

ELLIPSE EVO SPORTING STOCK



TRAP STOCK



CAESAR GUERINI: INNOVATIVE CUSTOM SHOP



ENGRAVING

- Custom engraving
- Your initials inlayed in gold on the trigger guard
- Presentation engraving on the trigger guard for such occasions as Retirement, Birthday, Graduation, etc.
- Create that special sentimental gift
- Engrave your initials in a stock medallion

OPTIONAL CUSTOMIZING

- Install custom leather covered recoil pads
- Installation Pachmayr or Kick-EEZ recoil pads (to modify length-of-pull)
- Install adjustable recoil pads
- Spacers to increase length of pull
- Reblue barrels
- Rust blue barrels
- Reblue steel fore-end irons, trigger guard, and top lever
- Rust blue steel fore-end irons, trigger guard, and top lever
- Re-jewel barrel flats
- Refinish metal and wood back to Factory Fresh
- Test fire gun for pattern
- Internal detailing / polishing internal parts

Commitment, Passion, and Craftsmanship are the three words that embody the Caesar Guerini Custom Shop. In our commitment to be the best at what we do, Caesar Guerini has created a state of the art gunsmithing facility and recruited top gunsmiths to serve our customers. We have a passion for exceeding our customers' expectations by creating new features and services at very competitive prices. Old world craftsmanship still exists at Caesar Guerini, and this dictates we do the job with traditional techniques and workmanship. If you are looking for a special shotgun crafted to your specifications, contact us to speak with one of our gunsmiths.

Visit GueriniUSA.com for a full list of services and pricing.



WOODCRAFT

- Custom stock made to customer's specifications
- Custom stock with DTS adjustable comb
- Custom Gun Fitting charge (waived with purchase of new shotgun)
- Custom Checkering Pattern
- Wood upgrades
- Completely refinish your Caesar Guerini "Supreme" oil finish including 20 or more coats of oil.
- Standard stock refinishing
- Re-cut checkering
- Add a gold, silver or brass stock medallion to your existing Caesar Guerini stock
- Reshape and refinish your existing Caesar Guerini comb to your custom stock dimensions
- Install wooden butt plates (to modify length-of-pull)
- Install DTS Kinetic Balancer in any sporting or trap model

SERVICES

- All non-warranty work (per hour)
- Fit barrels
- Fit barrel and fore-end
- Install Double release trigger (12 gauge only)
- Install Single release trigger (12 gauge only)
- Install double triggers
- Install automatic safety
- Remove Automatic Safety
- Fit stock and fore-end
- Install safety with selector
- Convert release back to pull
- Replace top rib Impact, Trap and Invictus models



CAESAR GUERINI: ACCESSORIES & APPAREL



BARRELS

- Field Barrel (12, 20, 28, and .410 gauge. Available in 26", 28", and 30".)
- Solid/Tapered Top Rib for Field Barrel (12, 20, 28, and .410 gauge in 28" only.)
- Sporting Barrel (12, 20, 28, and .410 gauge) available in 30", 32" and 34" - 34" in 12 gauge only.
- Impact O/U adjustable rib barrel in 12 gauge 30", 32", and 34"
- Impact O/U adjustable rib barrel in 20 gauge 32".
- Impact unsingle adjustable rib barrel in 12 gauge 34".
- Adjustable rib unsingle trap barrel in 32" and 34".
- Adjustable rib O/U trap barrels in 30" and 32".
- Field Combination Set, barrel & fore-end: all models, gauges, and barrel lengths.
- Sporting Combination Set, barrel & fore-end: all models, gauges, and barrel lengths.

* Fitting is required for all extra barrels and fore-ends. Choke tubes not included.

WOOD

- Field model stocks are available in all grades and gauges.
- Sporting clay stocks are available in all grades and gauges.
- DTS adjustable comb trap stocks available in all grades, in 12 gauge only.
- English style straight grip stocks are available in all grades and gauges.
- Left hand stocks are available as an option.

- Fore-ends are available in all grades and gauges.
- Wood upgrades available.
- Wood Butt Plate (Unfinished)
- Rubber Recoil Pad (Unfinished)
- Wood Finishing Kit

* Replacement stock and/or fore-end requires fitting.

CG GUN CASES

- Caesar Guerini Soft Gun Case
- Standard Fitted Hard Case (up to 30" barrels).
- Standard Fitted Hard Case (up to 34" barrels).
- Combo Case - Three Barrel (up to 34" barrels)
- Combo Case - Two Barrel Trap Gun (up to 34" barrels)

Caesar Guerini Italian Leather Cases:

- Leather Gun Case (up to 30" barrels)
- Leather Gun Case (up to 34" barrels)
- Leather Gun Case - Two Barrel (up to 34" barrels)
- Leather Gun Case - Three Barrel (up to 34" barrels)
- Leather Gun Case - Two Barrel Trap Combo (up to 34" barrels)

Caesar Guerini Custom Americases:

- Skeet 20g 28g .410g Tube Set case.
- Single barrel case up to 34" barrels.
- Two barrel Combo case up to 34" barrels.
- Three barrel Combo case up to 34" barrels.

MISC. ACCESSORIES

- Maxis Competition Chokes, 12 gauge only.
- CCP Competition Choke Tube (12, 20, 28 and .410 gauge).
- Selecta Choke, flush fitting (12, 20, 28 and .410 gauge).
- Choke Wrench-Selecta Choke (12, 20, 28 and .410 gauge).
- Friction Choke Wrench-Maxis and CCP competition chokes.
- Choke Tube Case for competition chokes.
- Choke Tube Case for field chokes.
- DTS multi wrench.
- T-handle Stock Wrench.
- DTS Kinetic Balancer.
- Barrel Balancer Weights.
- Cloth Barrel and Stock Sleeves.
- Automatic Safety.
- Soft Comb.
- Caesar Guerini Range Bag.
- Caesar Guerini Stickers and Decals.

CLOTHING

- Caesar Guerini Italian Shooting Vest.
- Caesar Guerini Premium Hat.
- Caesar Guerini T-Shirt.
- Caesar Guerini T-Shirt – Long-sleeve.
- Caesar Guerini Polo shirt.
- Caesar Guerini Hoodie.
- Caesar Guerini Sweatshirt.





WARRANTY & PROGRAMS

Limited Lifetime Warranty

CAESAR GUERINI U.S.A., LLC, a Maryland limited liability company (the "Distributor") is the proud distributor of the firearm which you have purchased manufactured by Caesar Guerini s.r.l. (the "Manufacturer"). In our desire to provide you with superior customer service in connection with your firearm, the Distributor wishes to provide you the following extended warranty for your firearm which is, in addition to, and exceeds the Manufacturer's warranty which you received with your firearm at the time of purchase.

To benefit from this Distributor's warranty, you will need to complete and return to the Distributor the Distributor Registration Card by certified or registered mail within thirty (30) days of date of purchase.

THE DISTRIBUTOR WARRANTS THAT THIS FIREARM WAS MANUFACTURED FREE OF DEFECTS IN MATERIAL OR WORKMANSHIP WHICH ADVERSELY AFFECTS THE OPERATION OF YOUR FIREARM FOR THE SHORTER OF THE LIFE OF THE PARTS OR THE ORIGINAL OWNER. THIS WARRANTY IS NON-TRANSFERABLE AND IS LIMITED TO THE ORIGINAL PERSONAL RETAIL PURCHASER. SUBJECT TO SUCH LIMITATIONS AS ARE SET OUT BELOW, THE DISTRIBUTOR AGREES TO CORRECT ANY DEFECT IN MATERIAL OR WORKMANSHIP IN YOUR FIREARM WHICH ADVERSELY AFFECTS THE OPERATION OF YOUR FIREARM, AS DETERMINED BY THE DISTRIBUTOR'S TECHNICIANS, BY REPAIR OR REPLACEMENT (AT DISTRIBUTOR'S DISCRETION, AND IF THE FIREARM IS TO BE REPLACED, WITH THE SAME OR COMPARABLE QUALITY FIREARM).

The Distributor does not warrant the wood (stock or fore-end), or metal finish with respect to finish, matching of pieces, dents, scratches, cuts, dings, etc. which are or should be apparent to the purchaser when the product is purchased or which occur after purchase. It is the customer's responsibility to inspect this particular product prior to purchase to ensure that it is free from defects or damage. This Warranty is effective from the date of the original retail purchase of the firearm.

THE DISTRIBUTOR ASSUMES NO RESPONSIBILITY FOR FIREARM MALFUNCTION OR FOR PERSONAL INJURY OR PROPERTY DAMAGE OR DEATH RESULTING IN WHOLE OR IN PART FROM CRIMINAL OR NEGLIGENT USE OF THE FIREARM, IMPROPER OR CARELESS HANDLING, FAILURE TO PERFORM PRESCRIBED MAINTENANCE AS SET FORTH IN THE USER AND MAINTENANCE MANUAL ATTACHED TO YOUR FIREARM AT THE TIME OF PURCHASE, UNAUTHORIZED MODIFICATIONS, USE OF

DEFECTIVE, IMPROPER HAND LOADED, RELOADED OR REMANUFACTURED AMMUNITION, CUSTOMER ABUSE OR NEGLECT OF THE PRODUCT OR OTHER INFLUENCES BEYOND THE DISTRIBUTOR'S DIRECT AND IMMEDIATE CONTROL. THIS WARRANTY DOES NOT APPLY TO NORMAL WEAR AND TEAR OF ANY PARTS, INCLUDING METAL, WOOD, PLASTIC, RUBBER, SURFACE FINISH OR OTHER MATERIALS, OR IF UNAUTHORIZED REPAIR AND/OR ALTERATION HAS BEEN PERFORMED.

THE DISTRIBUTOR'S WARRANTY IS LIMITED TO THE WARRANTY PROVIDED HEREIN AND THE DISTRIBUTOR DOES NOT MAKE ANY IMPLIED WARRANTIES, INCLUDING IMPLIED WARRANTIES OF MERCHANTABILITY OR FOR FITNESS FOR A PARTICULAR PURPOSE. THE DISTRIBUTOR SHALL HAVE NO RESPONSIBILITY FOR CONSEQUENTIAL OR INCIDENTAL DAMAGES OR EXPENSES.

This Distributor's Warranty cannot be changed except in writing by an authorized officer of the Distributor. Any warranty repair approved to be made to your firearm may only be made by an authorized repair facility. Dealers or gunsmiths (unless they are an approved repair facility) are not authorized to make any repair or adjustment on behalf of Distributor.

If your firearm should require warranty repairs, please contact the Distributor at the contact information on the attached "Warranty Assistance Sheet" and comply with the return instructions set forth thereon.

PitStop Maintenance Program

What is it? It is dedication to our customers that is unprecedented in the firearms industry. It is a belief that service does not end when the sale is finished. It is a promise to you that when you invest in a high quality Caesar Guerini shotgun you are going to get service that protects your investment and assures maximum performance from your firearm.

- As the original owner of a Caesar Guerini shotgun you can send your firearm to us once a year for a free service and tune-up. (up to three times)
- Your only cost is shipping.

The Pit Stop program is a great way to have your gun in top condition for the upcoming hunting or target season.



CAESAR GUERINI: BRESCIA, ITALY



Caesar Guerini: Brescia, Italy

Caesar Guerini's modern manufacturing facility successfully combines legendary Italian gunmakers' craftsmanship with technologically state-of-the-art processes to produce firearms unequaled for their performance, beauty and value. Our penchant for precision and perfection is reflected through the more than 256 inspection points that every firearm passes. Every Caesar Guerini Over-and-Under is indeed a modern classic, a functional example of Italian art.



Caesar Guerini Accolades:



- **Outdoor Life Magazine**
"Editor's Choice" 2003, 2007, 2009, 2011
- **Field & Stream Magazine**
"Best of the Best" 2003, 2008, 2010
- **Sporting Classics Magazine**
"Award of Excellence" 2005, 2013
"Company of the Year" 2014
- **Garden & Gun Magazine**
"Editor's Choice" 2009

CAESAR GUERINI

700 Lake Street
Cambridge, MD 21613
tel: (410) 901-1131
fax: (410) 901-1137
GUERINIUSA.COM

